

LEGEND^{NX}

LGX8N6CT2T

**NX Kit: 8 Channel 2 TB 4K NVR
Bundle with 6 x 4.1MP TURRETS**



In short

This comprehensive security camera kit includes six advanced 4MP surveillance cameras with smart target recognition, ChromaView 24/7 color imaging, 120 dB True WDR, and built-in microphones for clear audio monitoring, ensuring precise and efficient detection in any environment. The 8-channel NVR supports up to 8MP resolution, AI-powered features like SMD, perimeter protection, and face detection, and offers seamless ONVIF/RTSP compatibility with 4K HDMI output, providing a reliable and future-proof security solution.



Camera : LGNXT04CVLWF
4.1MP CHROMAVIEW LITE Fixed Turret
Network Camera

- 4MP High-Resolution Imaging
- Smart Target Recognition of humans & vehicles powered by deep learning
- ChromaView: 24/7 Colour Imaging
- 120 dB true WDR Technology
- IP67: Water and dust resistant
- Advanced H.265+ Compression
- Built-in Microphone

NVR : LGNX884KLN2T
8 CHANNELS 4K NVR WITH 8 POE/2TB

- 8-Channels IP Video input, up to 8MP (4K)
- AI by Camera: SMD, perimeter protection, face detection, etc.
- Incoming & Outgoing bandwidth: 80Mbps
- Supports ONVIF & RTSP protocols
- VGA/HDMI Simultaneous video output, maximum resolution of HDMI is 4K
- H.265+/H.265



*Design and specifications are subjects to change without notice.

Technical Specifications

Camera: LGNXT04CVLWF - 4.1MP CHROMAVIEW LITE Fixed Turret Network Camera

Camera	
Image Sensor	1/2.7 4MP Progressive Scan CMOS Sensor
Minimum Illumination	0.004 Lux at F1.0
Illuminated Reach	30m (ChromaView)
Embedded Features	Built-in Mic, Smart Illumination, ChromaView 24/7 color imaging
External Features	DC12V \pm 25%
Viewing Angle	Pan: 0° ~ 360° Tilt: 0° ~ 75° Rotation: 0° ~ 360°
Lens	
Focal Length	2.8 mm
Aperture	F1.0
Field of View	2.8 mm: Horizontal FOV: 101°, Vertical FOV: 54°, Diagonal FOV: 120°
Lens Mount	M12
Camera Image	
Maximum Resolution	4M (2688 \times 1520); 3M (2304 \times 1296); 1080p (1920 \times 1080); 1.3M (1280 \times 960); 720p (1280 \times 720); D1 (704 \times 576/704 \times 480); VGA (640 \times 480); CIF (352 \times 288/352 \times 240)
Frame Rate	Main Stream 2688 \times 1520 at 1 to 25/30 fps
	Sub Stream 704 \times 576 (1 fps to 25 fps); 704 \times 480 (1 fps to 30 fps)
Image Calibration	Brightness / Contrast / Hue / Saturation / Sharpness
Shutter Time	Auto/Manual, 1/3 ~ 1/100000s
Day/Night	Color / Black & White
Wide Dynamic Range	120dB
Digital Noise Reduction	2D/3D DNR
Supported Features	Backlight Compensation (BLC), Highlight Compensation (HLC), Region of Interest (ROI), Rotation
Compression	
Video Compression	H.265+ / H.265 / H.264+ / H.264 / MJPEG
H.265 Codec Profile	Main Profile
H.264 Codec Profile	Base / Main / High profile
Video Bit Rate	11 Kbps ~ 16 Mbps
Video Stream	Triple
Audio Compression	G.711A, G.711U
Audio Bit Rate	64 Kbps

*Design and specifications are subjects to change without notice.

Technical Specifications

Camera: LGNXT04CVLWF - 4.1MP CHROMAVIEW LITE Fixed Turret Network Camera

Intelligent Features	
Standard Events	Motion detection, Video Tampering
Advanced Events	Line Crossing Detection, Area Intrusion, Monitoring entry and exit for specific regions (supports alarm triggering by specified target types: human and vehicle)
Network	
Network Storage	NAS (NFS, SMB/CIFS)
Protocols	TCP/IP, ICMP, HTTP, HTTPS, FTP, DHCP, DNS, DDNS, RTP, RTSP, RTCP, NTP, IGMP, UPnP, SMTP, UPnP-TM, P2P
System Compatibility	Onvif (Profile S, Profile G, T), SDK
Security	Password protection, complex passwords, HTTPS encryption, IP address filtering, basic and digest authentication for HTTP/HTTPS, TLS 1.1/1.2, WSSE and digest authentication for Open Network Video Interface
Users	Maximum 40 users
Web Browsers	Internet Explorer 10 and 11 need a plug-in for live view support. Chrome 57.0+ and Firefox 52.0+ are required for local service
Mobile Surveillance	iOS, Android
Hardware	
Ethernet	1 RJ45 10 M/100 M self-adaptive Ethernet port
Storage	Up to 256GB
NDAA Compliant	Completely
General	
Working Conditions	-40°C ~ 60°C (-40°F ~ 140°F) Humidity 95% or less (non-condensing)
Power Supply	DC12V ± 25% / PoE (802.3 af)
Power Consumption	Less than 5.4W
Protection Level	IP67, 2KV
Material	Metal
Dimensions	Φ103.5 x 82.4 mm / Φ4.07" x 3.35"
Weight	0.99lb / 450g

Dimensions

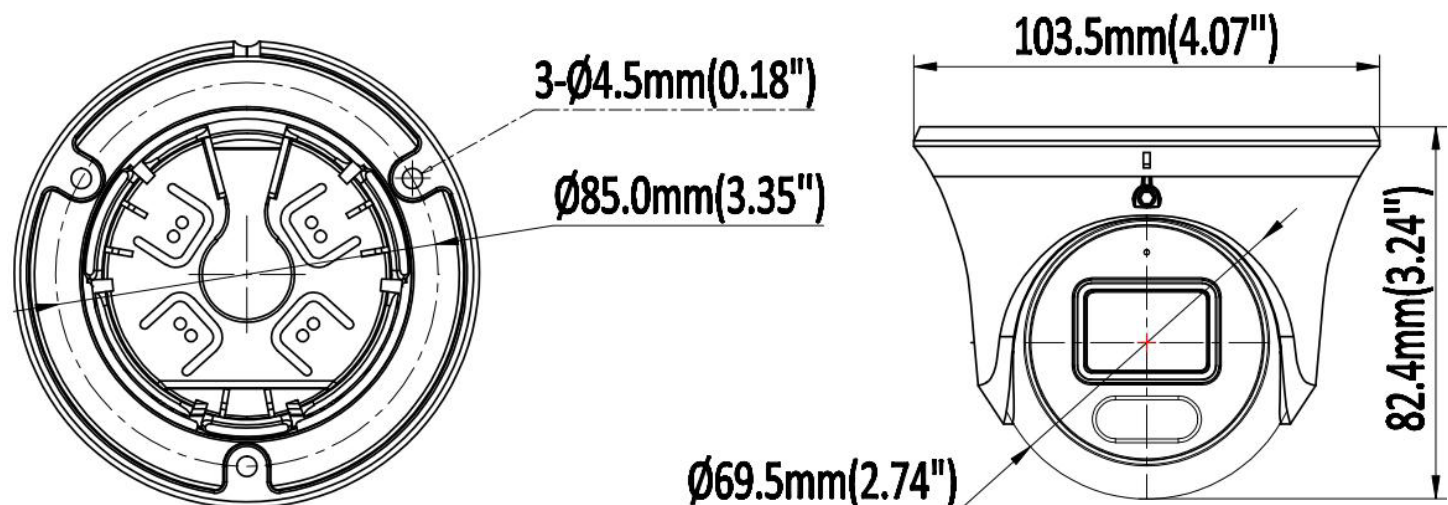

*Design and specifications are subjects to change without notice.

What you may need



XLGNXLB10
Junction Box
Φ112.5 mm × 49.5mm



XLGNXPM03
Pole Mount
Φ170mm × 135.8mm × 43.7mm



XLGNXLB14C
Wall Mount
Φ120mm × 105.8mm x 183.5mm



XLGNXCM700
Pendant Mount Bracket
Φ116 mm × 734.5 mm

Accessories Mount

XLGNXLB10



XLGNXLB14C

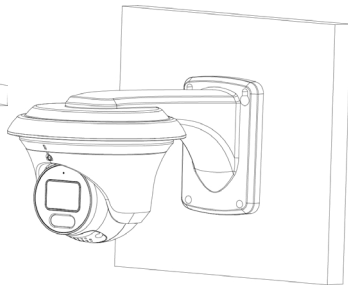

XLGNXLB10 + XLGNXLB14C

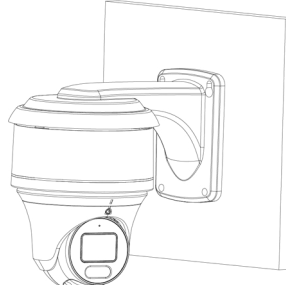

XLGNXLB10 + XLGNXCM700

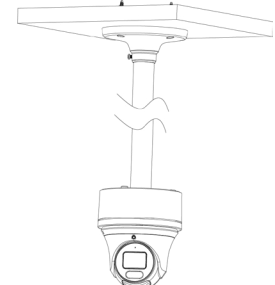

XLGNXPM03

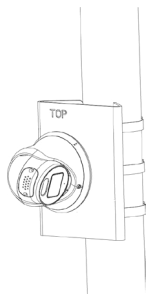

XLGNXPM03 + XLGNXLB10



XLGNXPM03 + XLGNXLB14C

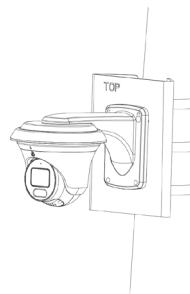

XLGNXPM03 + XLGNXLB10 + XLGNXLB14C

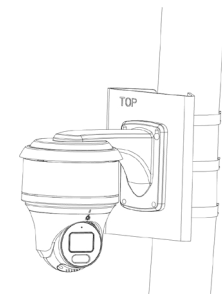

*Design and specifications are subjects to change without notice.

Technical Specifications

NVR: LGNX884KLN2T 8 Channels 4K NVR with 8 POE/ 2TB

Video and Audio Input	
IP Video Input	8-Channels
Audio Input	1-Channel, RCA
Video and Audio Output	
HDMI	1-Channel, Resolution : 4K (3840×2160) /30Hz, 1920 × 1080/60Hz,1280 × 1024/60Hz, 1280 × 720/60Hz
VGA	1-Channel, Resolution: 1920×1080/60Hz, 1280 × 1024/60Hz, 1280 × 720/60Hz
Audio Output	1-Channel, RCA
Recording	
Compression	H.265+/ H.265/ H.264+/ H.264
Resolution	8MP / 5MP / 4MP / 3MP / 1080P / 720P / D1 / CIF / QCIF
Bit Rate	64Kbps ~ 10Mbps
Playback and Backup	
Playback Resolution	8MP / 5MP / 4MP / 3MP / 1080P / 720P / D1 / CIF / QCIF
Decoding	1-Channel, 8MP @ 30fps 2-Channels, 6MP @ 30fps 2-Channels, 5MP @ 30fps 3-Channels, 4MP @ 30fps 6-Channels, 1080P @ 30fps
Synchronous Playback	8-Channels
Playback Mode	Smart Playback: Enhanced playback with advanced search features, such as motion or object detection for faster review
	Normal Playback: Standard, continuous playback of recorded footage
	Segmented Playback: Splits recorded footage into time segments for easier navigation
	Tagged Playback: Allows playback of video segments that have been labeled or tagged for easy access
	Event Playback: Focuses playback on recorded events like motion detection or alarms
	Log Playback: View recorded footage
Backup Mode	USB Device / Network
Advanced Features	
Smart Detection	Area intrusion, line crossing, region entry/exit, rapid movement, missing object, unattended object, loitering detection, parking detection, face detection, crowd gathering detection, blur detection, scene change detection, audio anomaly detection, human detection, vehicle detection, SMD (Smart Motion Detection), perimeter protection (PP).
Smart Playback	Face detection / Line crossing / Area intrusion / Motion detection / Human detection / Vehicle detection
Cloud Storage	Supported
Cloud Upgrade	Supported
Network	
Incoming Bandwidth	80 Mbps
Outgoing Bandwidth	80 Mbps
Ethernet	1 RJ-45 10/100 Mbps self-adaptive Ethernet interface
Network Compatibility	HTTPs, HTTP, TCP/IP, IPv4, UPnP, RTSP, UDP, SMTP, SNMP, NTP, DHCP, DNS, IP Filter, DDNS, FTP, P2P, ONVIF
Smart Phone	IOS (iPhone, iPad) , Android (Phone, Pad)

*Design and specifications are subjects to change without notice.

Technical Specifications

NVR: LGNX884KLN2T 8 Channels 4K NVR with 8 POE/ 2TB

Hard Disk	
SATA	1 SATA interface
Capacity	Up to 14TB capacity for each HDD
External Interface	
POE Interface	8 independent 10 /100Mbps PoE Ethernet interfaces
USB Interface	Front panel: 1 × USB 2.0, Rear panel: 1 × USB 2.0
POE Power	96W (each PoE port is max 30W)
General	
Power Supply	DC48V 2.5A
Power Consumption	≤15W (without HDD and POE)
Working Environment	-10°C ~ +55°C / 10% ~ 90% RH
Dimension (W×D×H)	250 x 230 x 45 mm (9.84" x 9.06" x 1.77")
Weight	3.74 lb / 1.7 Kg

Dimensions

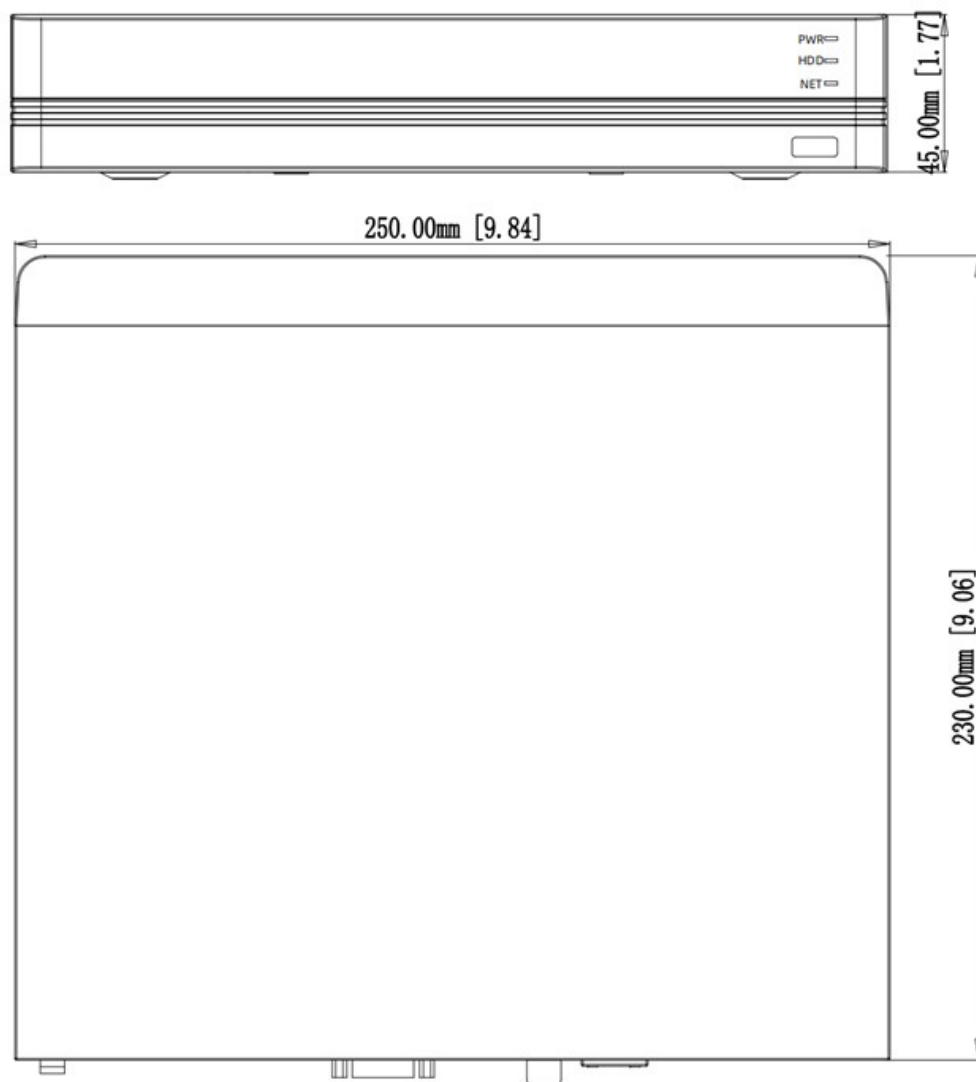

*Design and specifications are subjects to change without notice.

Rear Panel

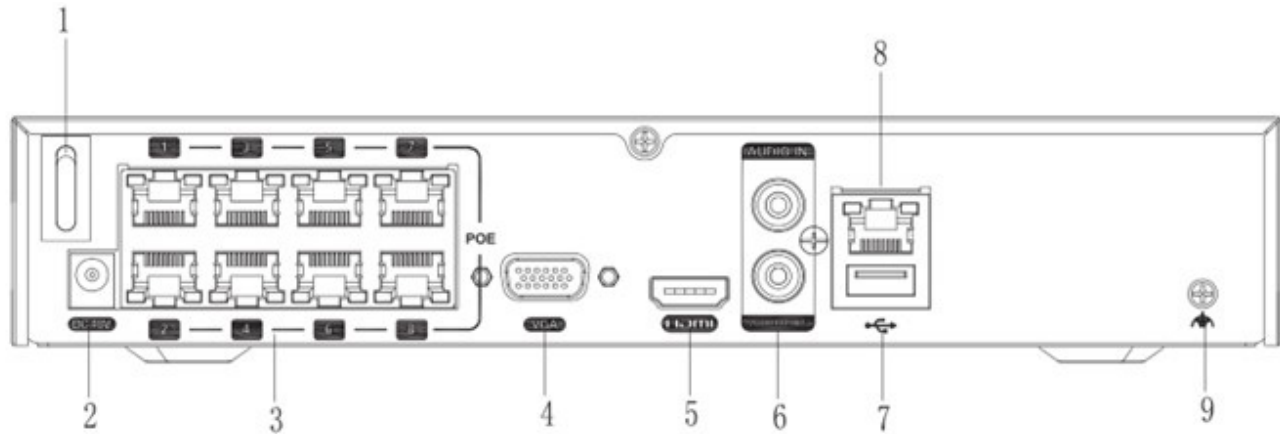

Part	Name	Part	Name
1	Power Switch	6	Audio IN/OUT RCA
2	Power Input	7	USB Port
3	POE Network Port	8	Network Port
4	VGA Port	9	Ground
5	HDMI Port		

*Design and specifications are subjects to change without notice.